

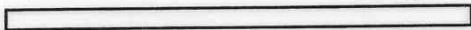

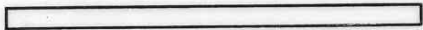









Gala Tent 4X8

-Parts List-



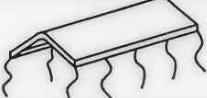
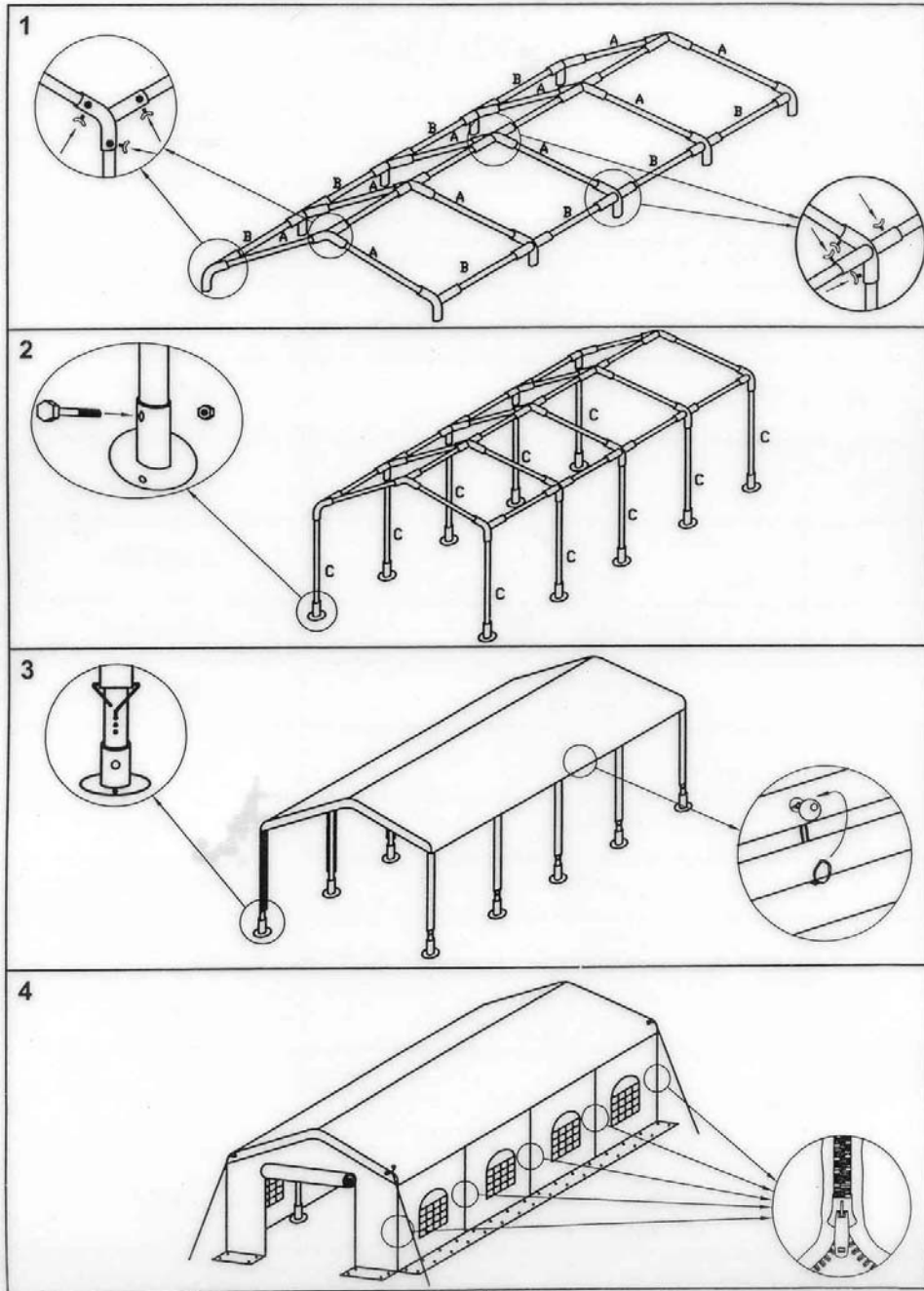

| Quantity | | Description |
|----------|---|-----------------------------|
| 10 | A  | Rafter |
| 12 | B  | Apex and eave pole |
| 10 | C  | Leg |
| 10 |  | Base plate |
| 6 |  | 3 way joint |
| 9 |  | 4 way joint |
| 10 |  | Nut and bolt |
| 4 |  | Guy lines |
| 54 |  | Bolt |
| 60 |  | Bungee |
| 4 |  | Peg \varnothing 7x330mm |
| 126 |  | Peg \varnothing 4.5x180mm |
| 2 |  | End panel |
| 8 |  | Wall panel |
| 1 |  | Roof |

Gala Tent 4X8

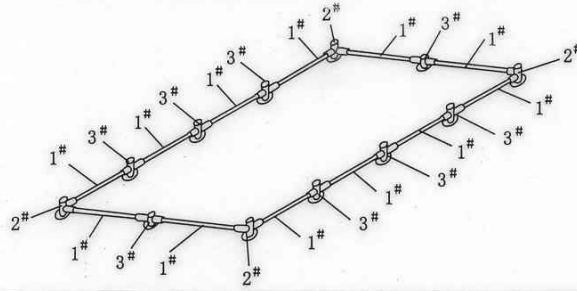

Ground Bar SIZE:4*8M



| NO | Part | | QTY |
|----|---|----|-----|
| 1 |  | 1# | 12 |
| 2 |  | 2# | 4 |
| 3 |  | 3# | 8 |
| 4 |  | 5# | 60 |

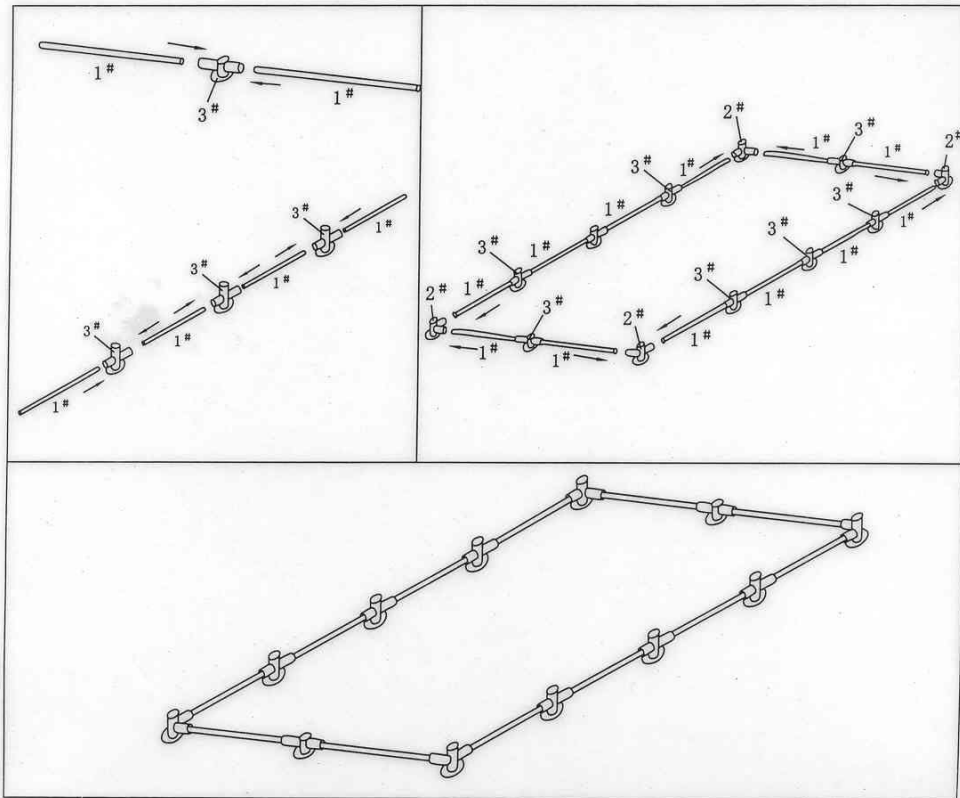

Marquee Assembly

Find a level piece of ground, ensure you have enough help to lift the marquee without straining yourself or the frame.

- 1. Lay out the roof frame. Ensure all parts are in their correct positions and then assemble roof frame. (A & B Poles)**
- 2. Lay the roof over the frame and attach using the bungee straps.**
- 3. Lift one side of the marquee and insert the legs (C Poles). Ensure that the holes in the poles are placed towards the bottom.**
- 4. If you intend to use the end wall panels it is easier to attach these now, before the marquee is at full height. Lift the other side of the roof, and attach the legs (C Poles).**
- 5. Attach the Ground bar set, link each leg together, leaving out individual sections where the entry and exit points are.**
- 6. Attach the sidewalls, as required using the bungee straps.**
- 7. Peg down or attach to the ground bar the bottom of each side and end wall.**
- 8. Secure and level the structure with Tie Down Kit as necessary.**